

ELKA BARRIER SYSTEMS

Series INDUSTRIAL - series S



ELKA barriers of the series INDUSTRIAL - series S are designed for the protection of industrial entrances and can be operated with folding skirts and folding top and bottom skirts. Perfect running performance, achieved by electronic speed control and optimized mechanics, protect motor and gear. An efficient drive concept and robust components ensure intensive operation with 100% duty cycle.

ELKA offers a selection of 3 barrier types of this series with different effective boom lengths and running times as well as suitable accessories for different purposes, e.g. boom lighting LED and safety devices.



Shortening of the barrier boom to the required length is free of charge



Optionally available in all RAL custom colours

Operation of legal and standard-compliant barriers

ELKA barriers of the series INDUSTRIAL - series S are offered in two versions - EU and UL version, according to the requirements of the European Union and North America (USA, Canada).

For the EU version there is a declaration of conformity according to the machine directive, a declaration of performance according to the Construction Products Regulation and a TÜV certification according to the European standards. For the North American and Canadian market ELKA complies with the corresponding UL and CSA standards. Certification is carried out by the internationally active company Intertek, which carries out quarterly inspections on production site at ELKA in Tönning, Germany.

ELKA creates the prerequisite that operators and commissioning engineers are always on the safe side when it comes to questions of liability.



Technology in detail

- **Housing hood**
simple removal,
without tools

- **Robust mechanics**
for intensive operation with
100% duty cycle, with vandalism
protection

- **Cable bushing**
comfortable - plenty of room

- **24V BLDC motor / gear**
multistage planetary gear,
powerful and energy-saving

- **Controller**
electronic speed control,
can be swung out to the side

- **Top-hat rail**
space for additional installations

- **Spring assembly**
for balanced barrier
movements



- **Barrier boom made of aluminium**
middle boom connector,
left / right usable, pre-assembled

- **Power reversal**
power reversal upon encountering
an obstacle

- **Emergency release**
fast and simple

- **Comfortable service**
power outlet, service switch
deactivates all external operating
commands

- **Terminal row**
professional connection of
accessories

- **Wide-range power supply**
IP68, high efficiency ratio

- **Barrier housing**
made of aluminium, powder-coated,
IP 54, with patent pending clamping
technology

Folding skirts and folding top and bottom skirts made of aluminium

ELKA barriers of the series INDUSTRIAL - series S can be operated with folding skirts and folding top and bottom skirts:

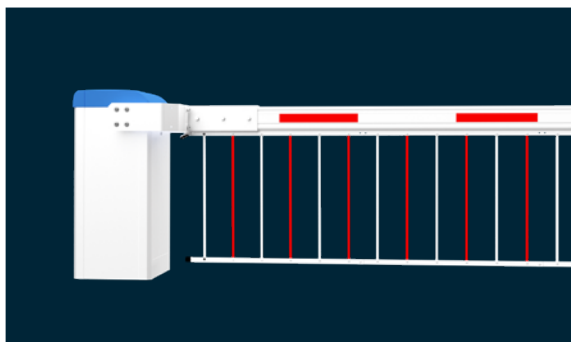

Folding skirt HG75 (S 5000 / S 6000 / S 8000)

- ✓ Height 29.5in
- ✓ Colour red / white
- ✓ Incl. spacer and guide plate for swinging support
- ✓ Max. boom length 315in
- ✓ Pre-assembled for on-site installation

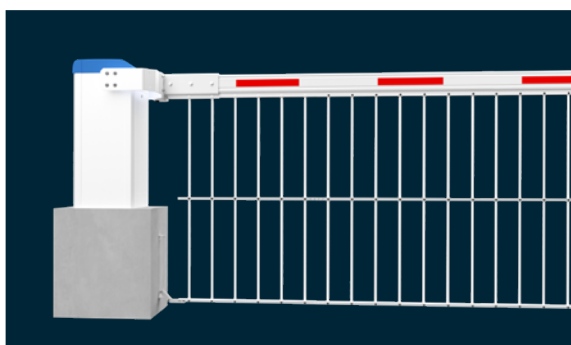

Folding skirt HG150 (S 6000 / S 8000)

- ✓ Height 59in
- ✓ Colour white
- ✓ Incl. guide bar, spacer and guide plate for swinging support
- ✓ Max. boom length 236.2in
- ✓ Pre-assembled for on-site installation

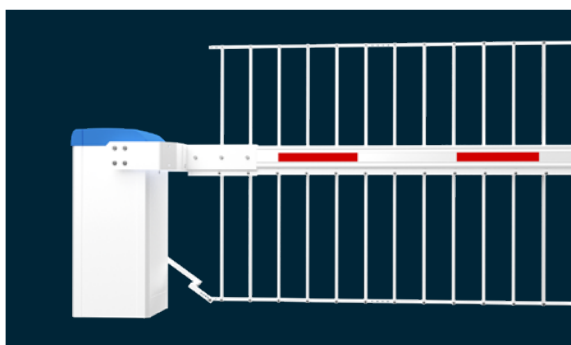

Folding top and bottom skirt SG150 (S 6000 / S 8000)

- ✓ Height 59in
- ✓ Colour white
- ✓ Incl. guide lever and spacer
- ✓ Max. boom length 236.2in
- ✓ Pre-assembled for on-site installation

Boom lighting profile with LED strip



Boom lighting profile with LED strip for boom length up to 8,000mm

The translucent rubber profile is evenly illuminated over the entire length by red, green or blue LED lights. The lighting type (permanent or flashing) can be set on the controller MO 24. The visibility of the barrier boom is significantly increased in darkness, poor visibility conditions and during the day. Operated with the appropriate running speed, barriers equipped with this new lighting profile comply with the permissible forces at the barrier boom (according to DIN EN 13241). The boom lighting profile can be used with fixed and swinging supports.*

- ✓ Evenly illumination of the entire boom length
- ✓ Translucent rubber profile
- ✓ Visible from both sides
- ✓ Multi-colour light
(red / green / blue possible)
- ✓ LED technology with low power consumption
- ✓ Protection class IP 68
(when preassembled ex works ELKA)
- ✓ Up to a barrier boom length of 6,000mm
pre-assembled ex works (complete barrier)
- ✓ Up to a barrier boom length of 8,000mm for
on-site assembly (incl. insertion tool)
- ✓ Can be shortened as required
- ✓ Mounted ex works or available as retrofit kit
- ✓ Easy to install
- ✓ Can be used with fixed and swinging supports

**The lighting is freely configurable via the barrier controller MO 24. Example:
Barrier closed = red, barrier in motion = flashes red, barrier open = green**

*Not usable with folding skirts or folding top- and bottom skirts.

LED boom lighting for the use with folding skirts and folding top and bottom skirts

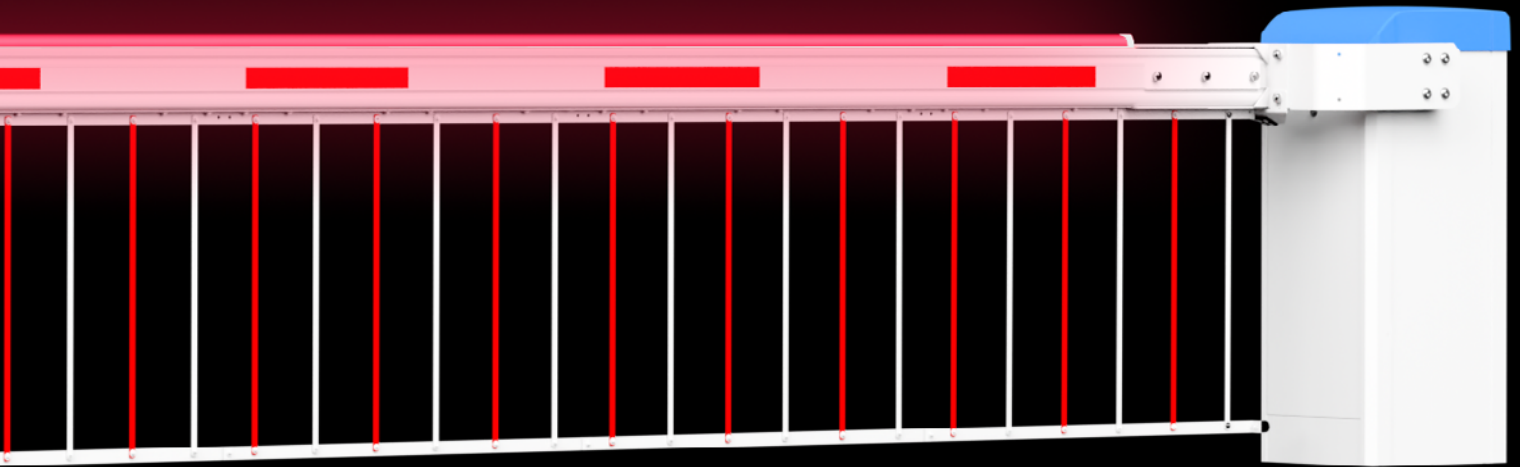

LED boom lighting for the use with folding skirts and folding top and bottom skirts

The barrier boom is evenly illuminated over the entire length by red, green or blue LED lights. The lighting type (permanent or flashing) can be set on the controller MO 24. The visibility of the barrier boom is significantly increased in darkness, poor visibility conditions and during the day.

- ✓ Evenly illumination of the entire boom length
- ✓ Visible from both sides
- ✓ Multi-colour light
(red / green / blue possible)
- ✓ LED technology with low power consumption
- ✓ Protection class IP 68
(when preassembled ex works ELKA)
- ✓ Up to a barrier boom length of 6,000mm
pre-assembled ex works (complete barrier)
- ✓ Up to a barrier boom length of 8,000mm for
on-site assembly (incl. insertion tool)
- ✓ Can be shortened as required
- ✓ Mounted ex works or available as retrofit kit
- ✓ Easy to install

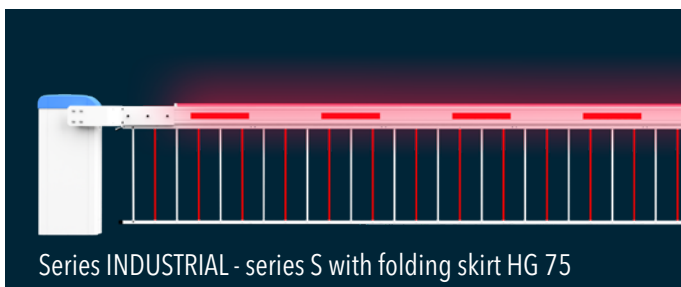

Series INDUSTRIAL - series S with folding skirt HG 75

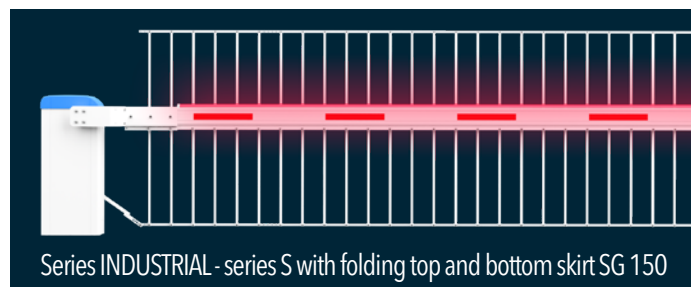

Series INDUSTRIAL - series S with folding top and bottom skirt SG 150

**The lighting is freely configurable via the barrier controller MO 24. Example:
Barrier closed = red, barrier in motion = flashes red, barrier open = green**

ELKA ECON APP



App for programming and controlling of ELKA barriers

Programming, operation and control of ELKA barriers with controller MO 24 and MO 64 „Plus“ - comfortable via mobile phone, tablet or PC. Only usable in combination with the ELKA ECON BOX.

Quick set-up

Simple project management, barrier configurations can be set and saved, backup of all settings

Professional maintenance

Analysing of the induction loops, error memory, service- and diagnostic report, diagnosis of all inputs and outputs of the controller

Comfortable

Notification and control of events in case of a status change, user management, 365-day-timer, differential counter

Access control devices



Desktop panels

Single, double, triple or quadruple keyboard, with illuminated keys, OPEN / CLOSE / STOP / ON-OFF



Switches

Flush or surface mounting, key switches including key, code switches with foil keypad or stainless steel keypad

Technical data

Type	S 5000	S 6000	S 8000
Housing dimensions (w/d/h) (in)	16 x 18 x 42		
Boom length (in)	196.9	236.2	315
Effective boom length approx. (in)	203.6	242.9	321.7
Running time approx. (s)	4.0 / 5.5 / 7.0	5.0 / 6.5 / 8.0	7.0 / 8.5 / 10.0
Duty cycle	100%		
Temperature range	-4°F up to +122°F		
Degree of protection	IP54		
Supply voltage	100V - 240V, 50Hz - 60Hz		
Current consumption	max. 1.4A (230VAC) / max. 2.8A (115VAC)		
Weight without boom approx. (lb)	298	315	344
Boom weight approx. (lb)	22	35	49

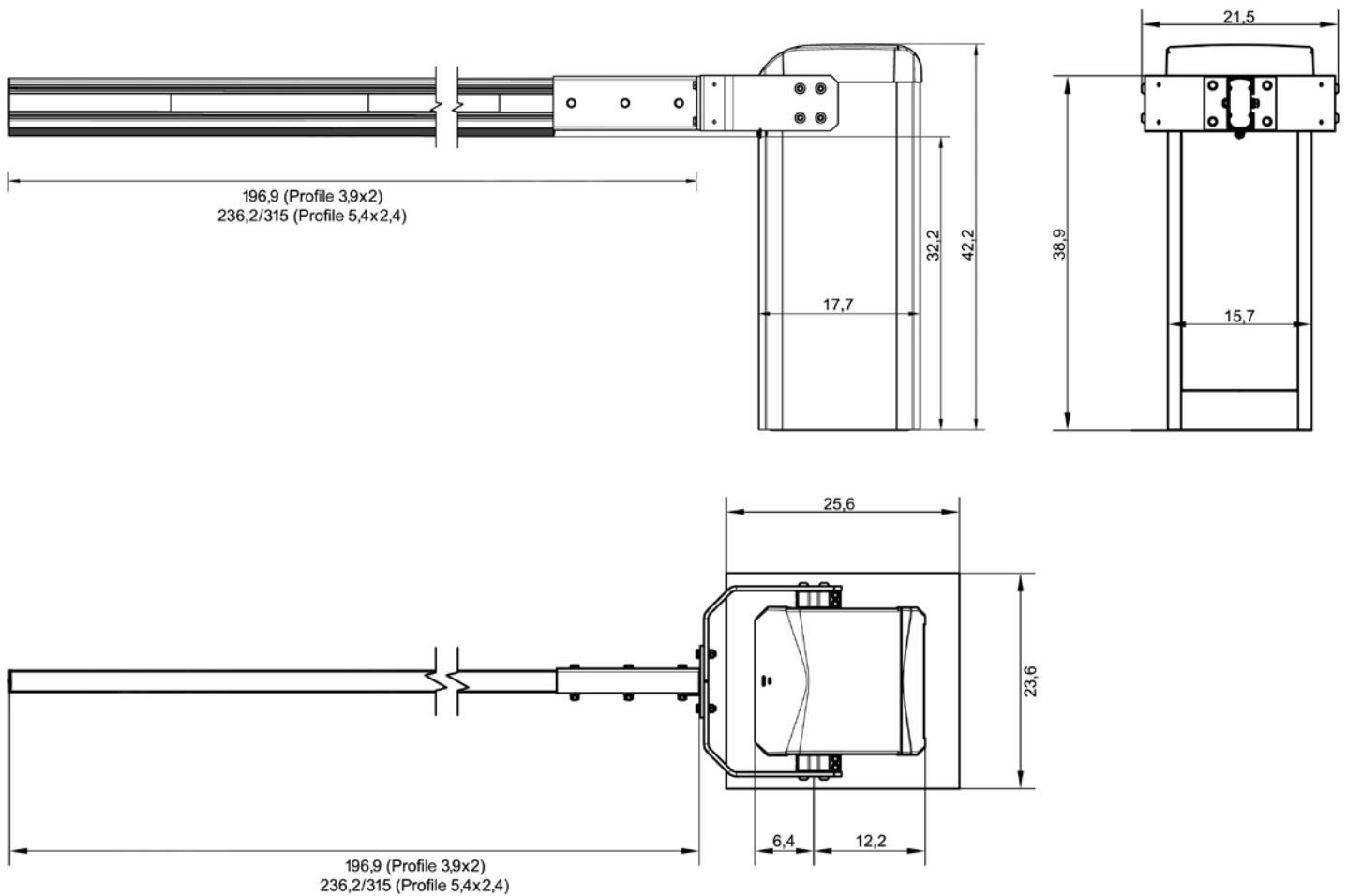

Equipment

Standard equipment	S 5000	S 6000	S 8000
Standard colours	Housing white / RAL 9010, housing hood blue / RAL 5012		
Boom connector	Middle boom connector		
Boom dimensions h/w (in)	3.9 x 2	5.4 x 2.4	
Controller	MO 24 with 4x7-segment-display		
Power reversal	connectable		
Terminal row	prewired		
1-channel loop detector	3 integrated		
Multifunctional relay	6 integrated (e.g. for traffic lights, boom lighting LED, etc.)		
Electronic speed control	yes		
Dead man's mode	yes		
Antenna connection	yes		

Special equipment	S 5000	S 6000	S 8000
Articulation kit*	optional		no
Round barrier boom	optional, \varnothing 3.9in		
Fixed and swinging support	optional		
Folding skirts and folding top and bottom skirts*	HG 75	HG 75 (up to 236.2in), HG 150, SG 150 (up to 177.2in)	HG 75 (up to 315in), HG 150, SG 150 (up to 236.2in)
Boom lighting*	as LED strip in the rubber tube on the underside of the boom or mounted on the boom		
Custom colours	optionally available in all RAL custom colours (extra charge)		
Photoelectric barrier	optional		
Laser scanner	optional, free-standing installation or mounting on the barrier housing (two laser scanners are required when using folding skirts or folding top and bottom skirts)		
24V loading module	optional, uninterrupted barrier operation in case of a power failure (on-site batteries required)		
Automatic OPENING	optional		
Radio remote control receiver	socket available		
Weekly timer / yearly timer	optional		
TCP-IP-module	optional (socket available)		
Multifunctional relay	optional module with: 4 additional multifunctional relays (AMR4) / 8 additional multifunctional relays (AMR8)		
Access control	Key switch, code switch, etc.		

* not available for round barrier booms

ELKA TORANTRIEBE

Partner with competence



ELKA is a German manufacturer of gate openers and barrier systems of high quality with an experience of more than 40 years. We place a great value on high quality components, easy installation and customerfriendly service. Our products are developed and assembled in Germany and are subject to strict quality controls.

„Partner with competence“ - the management as well as the employees feel committed to this philosophy. We supply products to over 80 countries worldwide and support our customers in three languages. Technically trained specialists and engineers respond to individual customer requirements. Fast order processing, short delivery times and adherence to deadlines are a matter of course for us.

You can find more information on our website: www.elka.eu

✓ **Competent customer service**

✓ **Quality „Made in Germany“**

✓ **Prompt handling and reliability**

Inhouse-Seminars

Gate openers- and barrier seminar with expert certificate. According to legal regulations, power-operated gate and barrier systems must be checked at least once a year. Only experts with a valid certificate are authorized to carry out the inspection and documentation. ELKA supports its partners in this and offers further training in its own premises in Tönning, Germany.

The ELKA team is looking forward to your questions and registrations: akademie@elka.eu



ELKA-Torantriebe GmbH u. Co. Betriebs KG
Dithmarscher Str. 9, 25832 Tönning / Germany

✉ info@elka.eu

🌐 www.elka.eu

☎ **+49 (0) 4861-9690-0**

📠 **+49 (0) 4861-9690-90**